

*R. L. Foote
Design Studio*



Delicately crafted in Melbourne, Australia



Contact:

W: www.RLFooteDesign.com

E: info@rlfootedesign.com

IG: [@rlfootedesignstudio](https://www.instagram.com/rlfootedesignstudio)

T: +61 (0) 404 873 127

About R L Foote Design Studio

R L Foote Design Studio is a Melbourne, Australia based design studio focused on delivering some of the most unique and contemporary ceramic flatware, silicon food moulds, interior design objects and event based designs. We meticulously create everything in our Clifton Hill studio workshop.

The studio has a particular interest in the designed food and beverage experience, thinking not only about the physical elements of the space, flatware, tables, seats but also the ephemeral experience that runs along side these objects. Imagining how the food and drink is served, eaten, played with, we conceptualise new food forms, textures, tastes, cultural influences and their effect on the dining experience.

R L Foote Design Studio was founded by installation Artist, Designer, Chef and Food Designer Ryan L Foote whose diverse background provides a unique source of knowledge and inspiration.

Working with restaurants, interior designers and chefs, R L Foote Design Studio can design and produce customised flatware and objects to clients specification.

Tiki Cups

Fun and playful, these tall contemporary tiki cups are made in coloured porcelain with glaze oozing down the sides to create a dramatic effect. This cup would give any of your cocktail creations an edge, adding to the drinking experience.

85mm dia x 150mm

TK-01-
B (Bright blue), W (White),
P (Pink), M (Mint),



Crystalline Cups

Extensive testing and refinement has occurred to discover a precise formula of up to ten minerals which creates this crystalline effect. Available in two shapes, these cups are short, perfect for refilling from a teapot or enjoying a short cocktail.

83mm dia x 75mm

CG-C-02-
G (Golden), JA (Jade),
WA (Wattle), SA (Sapphire)
SO (Southern Ocean), T (Turquoise)

Tenmoku Range

Designed to be a wide rice bowl, these footed dishes can be finished in a variety of muted and natural tones with a smooth or textured surface. Available in a satin to matte finish, your food can do all the talking when plated on this simple and bold shape.

Small: 135mm dia x 55mm
TG-B-01-

Large: 215mm dia x 75mm
TG-B-02-



Tenmoku Cups

Using the traditional Japanese tenmoku style, these highball cups are simple in presentation, yet complex in finish. Buy a set or mix and match to create a personalised collection.

52mm Dia x 147mm

TG-C-01-

Colour code to go after SKU code

B (Black), P (pink Gum), S (Sand), DB (Dark Brown Gum), PB (Purple Blue)

GL (dark Gum Leaf) BG (brown Gum), DS (Desert Sand), BG (Blue Gum),

GL (Gum leaf), SG (Snow gum), SM (Smoked Gum)

3D Printed Range

R. L. Foote
Design Studio



80mm dia x 100mm
3D-C-01-W



One of our latest pieces is out digitally generated porcelain cups paired with our crystalline plates which were custom made for Chocolates By Ryan L Foote to compliment his unique chocolate designs.

We have the ability to draw up and design very different shapes and forms for clients needs.



55mm dia x 100mm
3D-C-02-W

Aperitif Cup

The perfect size for holding an afternoon aperitif, this cup is simple yet the scalloped detail provides complexity. With a matte exterior and gloss finish inside, you can pour and enjoy anything sippable, just add sunset!



Sake Cups

With an endless variety of glaze options, these sweet sake cups are a pleasure to hold and sip from. They work as a matching collection or with a mix of colours and finishes.



50mm dia x 55mm
3D-C-03-W

50mm dia x 55mm
3D-C-04-W

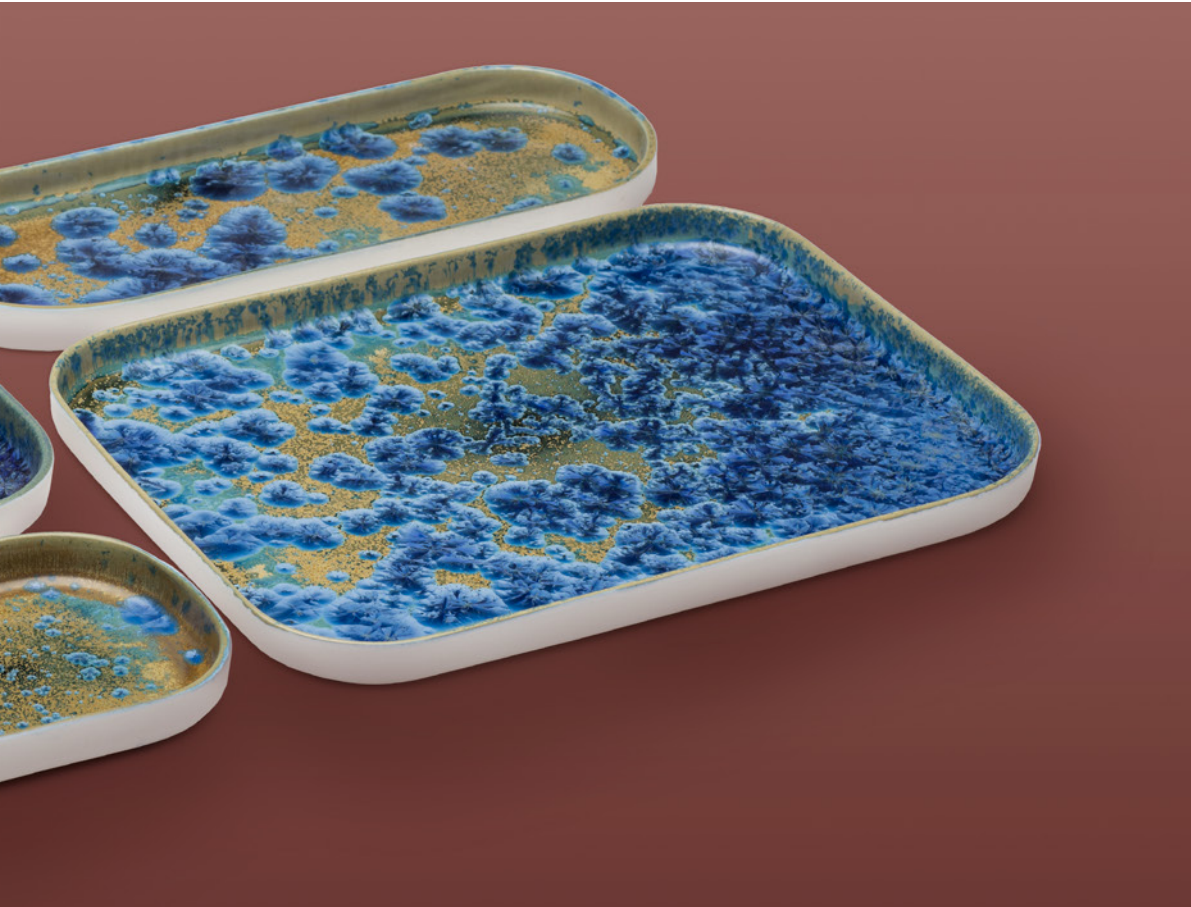

Our breathtaking Crystalline Range featuring our most unique and complex glaze yet!

Part art part alchemy, each glaze contains about 10 different minerals that are painstakingly mixed and applied to the ceramics.

The pieces are then fired, during the extreme heat and atmosphere of the kiln, crystals start to form, growing to reveal their fractal shapes and vibrant colours.

After years of testing and refinement we have developed a range of captivating glazes. Where each piece takes on its own identity in the firing making it completely unique and unrepeatable.

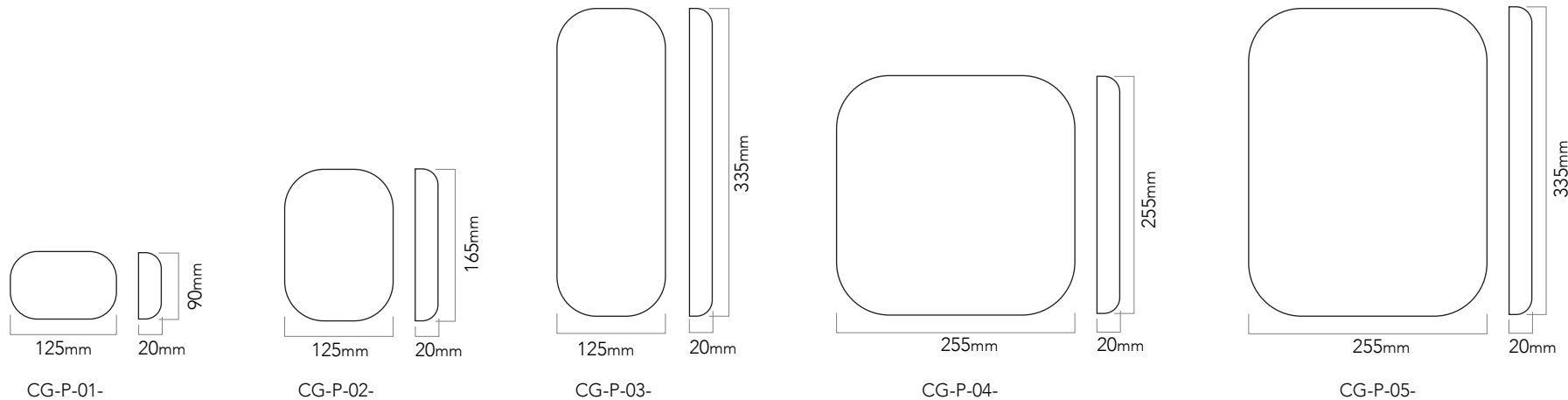

Colour code to go after
SKU code:

- AM (Amber)
- CC (Cobalt Coral)
- JA (Jade)
- SA (Sapphire)
- SO (Southern Ocean) WA (Wattle)
- G (Golden)
- T (Turquoise)

Crystalline Range

R. L. Foote
Design Studio



Crystalline: Opal
small dish to platter

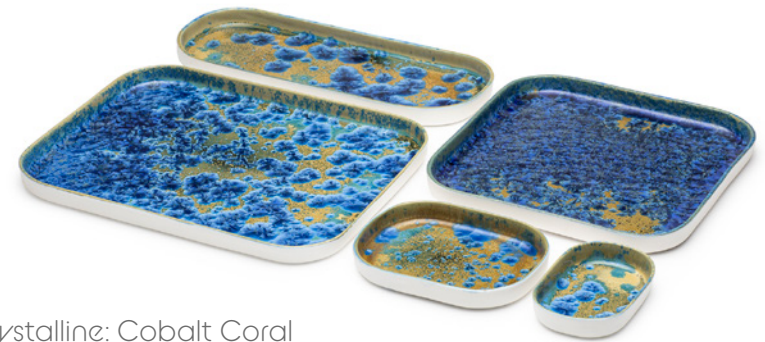

Crystalline: Cobalt Coral
small dish to platter

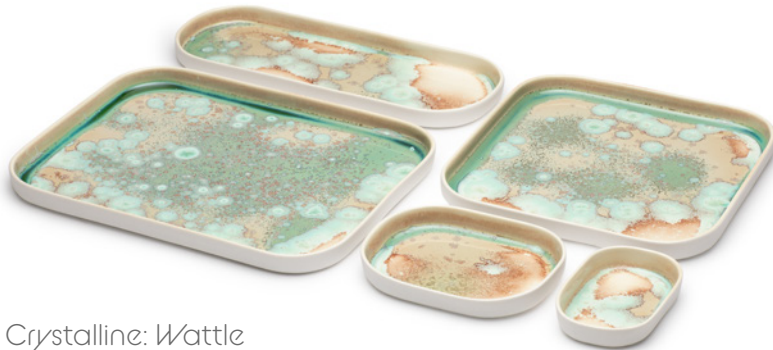

Crystalline: Wattle
small dish to platter



Crystalline: Amber
small dish to platter

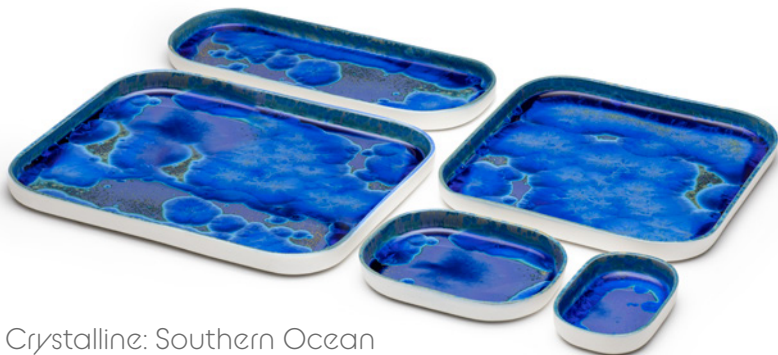

Crystalline: Southern Ocean
small Dish to platter



Crystalline: Jade
small Dish to platter

Crystalline Range

R. L. Foote
Design Studio

These luminous glazes like the name suggests grow crystals in the molten glaze during the firing process.



Crystalline Vase: Wattle
Large to Cup



Colour code to go after
SKU code:

- AM (Amber)
- JA (Jade)
- SA (Sapphire)
- SO (Southern Ocean) WA (Wattle)
- G (Golden)
- T (Turquoise)

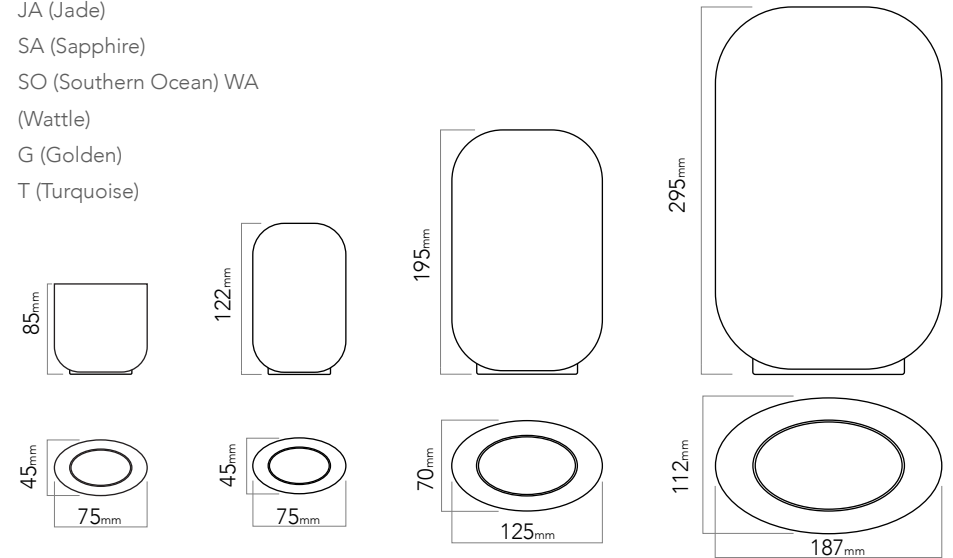

CG-C-01-
Crystalline
Cup

CG-V-01-
Crystalline Vase
Small

CG-V-02-
Crystalline Vase
Medium

CG-V-03-
Crystalline Vase
Large

Crystalline Range

R. L. Foote
Design Studio



Crystalline Vase: Southern Ocean
Large to Cup



Crystalline Vase: Jade
Large to Cup



Crystalline Vase: Opal
Large to Cup



Crystalline Vase: Amber
Large to Cup



The Diamond Lab platter is a beautiful sculptural piece which can be plated on either side.

The Diamond Lab range was originally developed to accompany Ryan L Foote's Popup Food Art Experience.

This unique diamond inspired popup event brings together and pushes the boundaries of the creative worlds of Fine Art, Gastronomy, Design and Fashion in one unforgettable experience.

Every element from the sculpted diamond table to crisp porcelain tableware and food grade moulds were delicately created by Ryan L Foote.

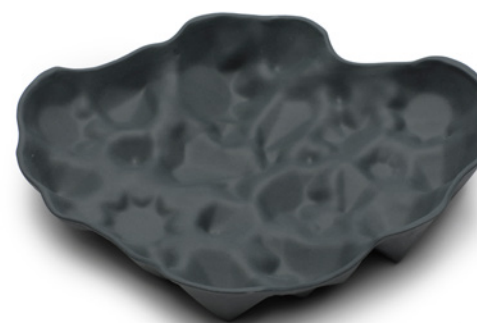

Diamond Lab: Platter
29cm x 25 cm x 5 cm

DL-P-03-



Tones:



Black (B)



White (w)



Diamond Lab: Pedestal
20 cm dia x 6.7 cm

DL-P-02-

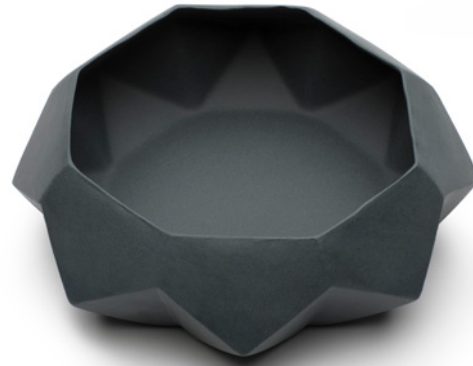

Diamond Lab: Bowl
20 cm dia x 6.7 cm

DL-B-01-



Diamond Lab: Tureen
20 cm dia x 8 cm

DL-P-04-



The Diamond Lab bowl, plate
and pedestals match &
complement each
other perfectly for
endless plating
possibilities.



Diamond Lab: Plate
20 cm dia x 2 cm

DL-P-01-

Colour code to go
after SKU code

B (Black) W (white)

Diamond Lab Range

R. L. Foote
Design Studio

The Diamond Lab Drip Infuser can be used to brew teas, coffees or infuse broths, enhance the dining experience with a playful element.



Diamond Lab: Drip infuser
10 cm dia x 7 cm

DL-DI-01-



Diamond Lab: Sald bowl
21 cm dia x 16 cm

DL-B-02-



Diamond Lab: Canapé bowl
10 cm dia x 7 cm

DL-B-03-

Diamond Lab: Salt cellar
7 cm dia x 4.5 cm

DL-B-04-

The diamond shapes bring both sophistication & playfulness to the table.



Blue Jade Range

R. L. Foote
Design Studio



Blue Jade: light



Blue Jade: Mid



Blue Jade: Dark

Blue Jade range is a clean contemporary design where pieces fit together or perfect on their own.



Blue Jade: Set 1



Blue Jade: Set 2

The range is made with stained clay & has a high gloss glaze finish

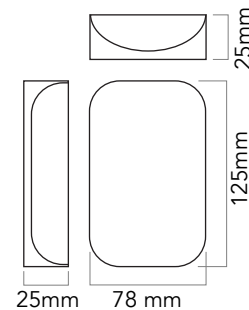

BJ-O1-

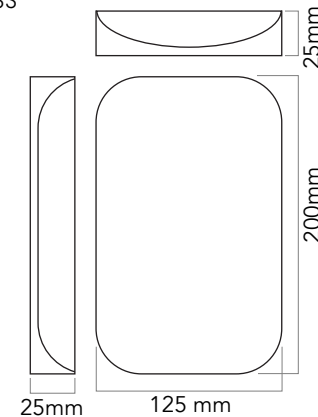

BJ-O2-

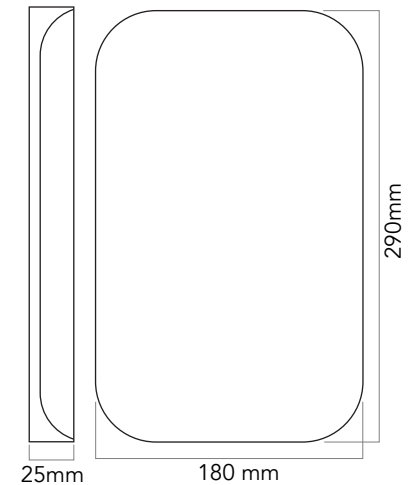

BJ-O3-

Colour code to go after SKU code
DB (Dark Blue Jade), LB (Light Blue Jade), MB (Mid Blue Jade)

Bento Range

R. L. Foote
Design Studio

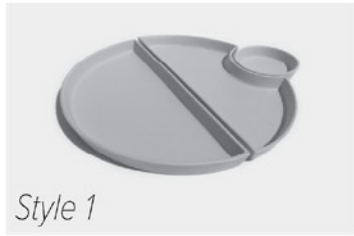

Style 1



Style 3



Style 5



Style 7



Style 9

Selection of styles that can be combined in single, dual or tri-tone sets.



Style 2



Style 4



Style 6



Style 8



Style 10

Our Bento Range is inspired by traditional Japanese bento boxes but with a contemporary twist.



Gift box available for Bento sets

Bento Range

R. L. Foote
Design Studio



Bento Style 0
Pink



Bento Style 1
Light Blue



Bento Style 6
Mint



Bento Style 9
Orange



Bento Style 2
White



Bento Style 3
Black



Bento Style 7
Pink



Bento Style 10
Light Blue



Bento Style 4
Orange

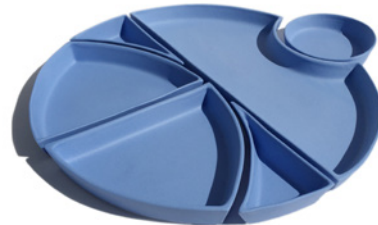

Bento Style 5
Blue



Bento Style 8
White



Bento Style 1
Black

Bento Range

R. L. Foote
Design Studio

Examples of combinations:



Bento Style 1 - Dual Tone
Blue, Pink



Bento Style 3 - Dual Tone
White, Orange

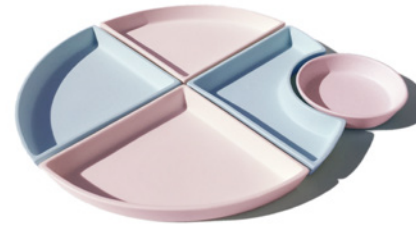

Bento Style 8 - Dual Tone
Light Blue, Pink

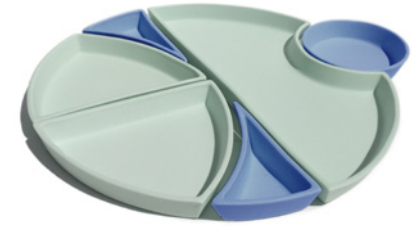

Bento Style 5 - Dual Tone
Blue, Mint Green



Bento Style 1 - Dual Tone
Light Blue, Mint



Bento Style 5 - Dual Tone
Black, White



Bento Style 7 - Dual Tone
Blue, Orange



Bento Style 10 - Dual Tone
Blue, White

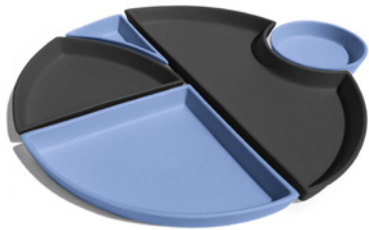

Bento Style 3 - Dual Tone
Black, Blue



Bento Style 6 - Dual Tone
Mint, Pink

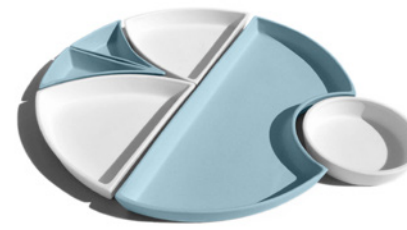

Bento Style 7 - Dual Tone
White, Light Blue



Bento Style 10 - Dual Tone
Black, White

Bento Range

R. L. Foote
Design Studio

Single Tone

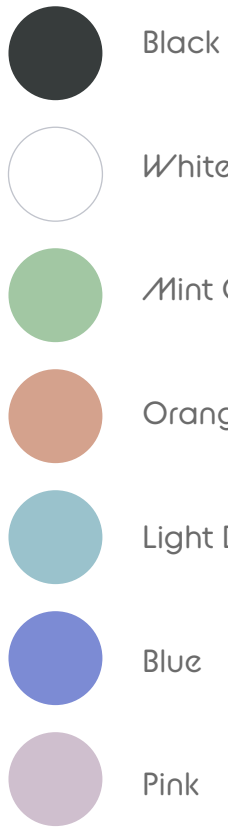

Dual Tones

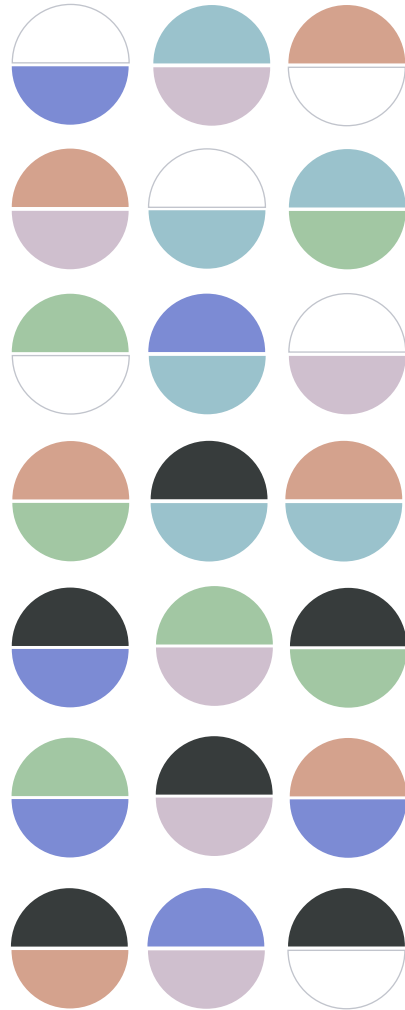

Tri Tones

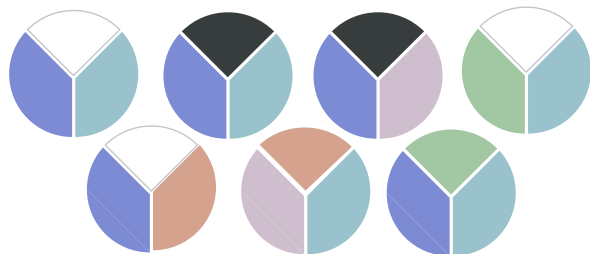

Individual Bento shapes:

Bento shape: B4
29 x 14cm by 2.5cm high

Bento shape: B3
29 x 13.5cm by 2.5cm high

Bento shape: B1
29cm wide by 2.5cm high

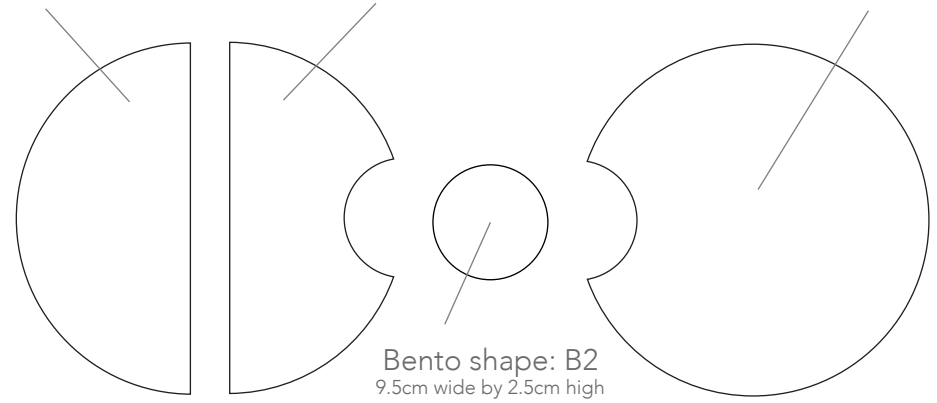

Bento shape: B2
9.5cm wide by 2.5cm high

Bento shape: B5
14 x 14cm wide by 2.5cm high

Bento shape: B8
12 x 7cm wide by 2.5cm high

Bento shape: B6
14 x 14cm wide by 2.5cm high

Bento shape: B7
14 x 12cm wide by 2.5cm high

Bento shape: B9
12 x 7cm wide by 2.5cm high

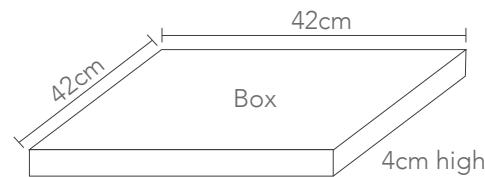

Individual Bento shapes only available for large orders only

Hong Kong Range

R. L. Foote
Design Studio



Sheung Wan: light blue, black, pink, blue



Sham Shui Po: green, red, blue



Kennedy Town: light blue, green, white

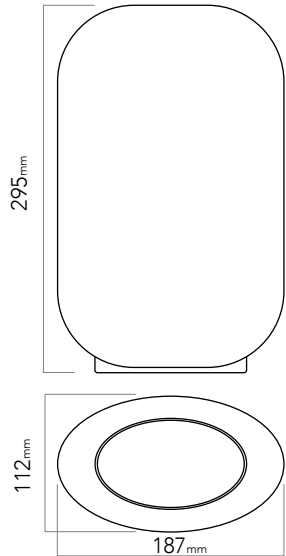

Hong Kong Vase Large

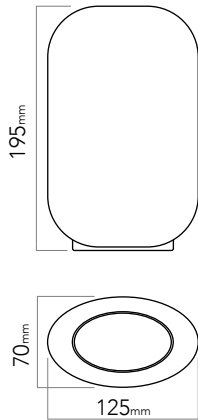

Hong Kong Vase Medium

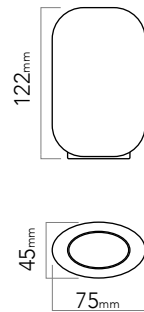

Hong Kong Vase Small

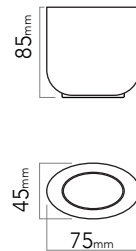

Hong Kong Cup

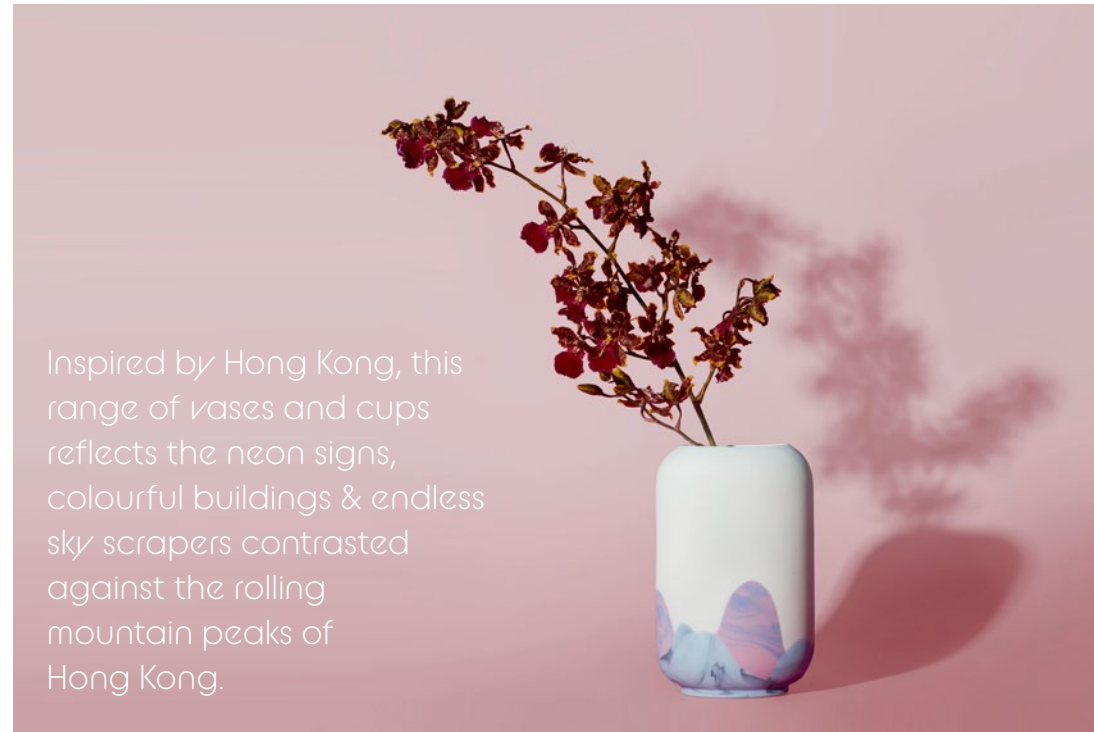

Inspired by Hong Kong, this range of vases and cups reflects the neon signs, colourful buildings & endless sky scrapers contrasted against the rolling mountain peaks of Hong Kong.

Bubble Range

R. L. Foote
Design Studio

Our Bubble range is hand crafted from fine white porcelain and features our signature glaze, hand applied to each piece making it one of a kind and unlike the next.



Available in full or partial coverage bubble glaze with gloss finish

Plate sizes:



9cm Dia
BG-P-01-



14.5cm Dia
BG-P-02-

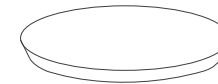

21.5cm Dia
BG-P-03-

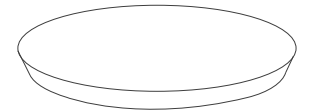

29cm Dia
BG-P-04-

Platter size:

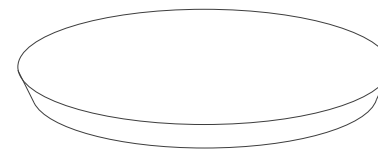

39cm Dia
BG-P-05-

3cm high

Colour code to go after SKU code

B (Black-Blue), BO (Blue & Orange)
BB (Blue & Blue-Black) LB (Blue & Light Blue)
PB (Blue & Pink), DG (Dark Green),
GY (Grey), GB (Light Blue & Green)
PR (Mauve), OB (Olive & Blue)
R (Red), RB (Red-Black)
RBL (Red & Black-Blue)

Bubble Range

R. L. Foote
Design Studio



Bubble Plate / Platter:
Purple - Partial Coverage

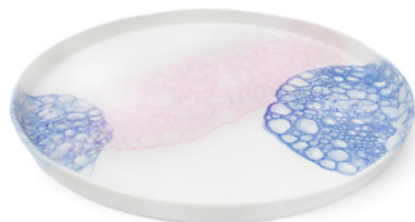

Bubble Plate / Platter:
Pink & Blue - Partial Coverage



Bubble Plate / Platter:
Blue & Light Blue - Partial Coverage



Bubble Plate / Platter:
Light Blue & Bright Green - Partial Coverage



Bubble Plate / Platter:
Red - Full Coverage



Bubble Plate / Platter:
Orange & blue - Partial Coverage



Bubble Plate / Platter:
Blue & Black/Blue - Full Coverage

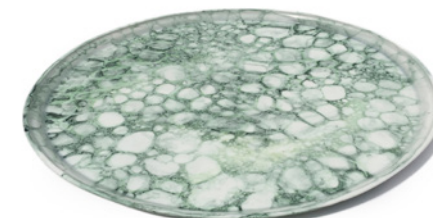

Bubble Plate / Platter:
Green - Full Coverage



Bubble Plate / Platter:
Red/Black - Full Coverage



Bubble Plate / Platter:
Grey - Full Coverage

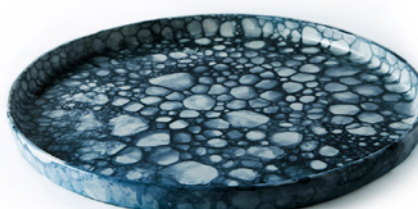

Bubble Plate / Platter:
Black/Blue - Full Coverage

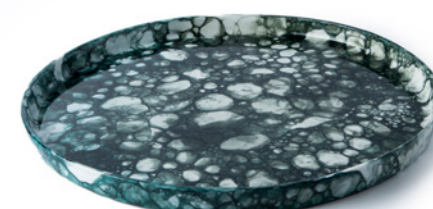

Bubble Plate / Platter:
Dark Green - Full Coverage

Bubble Range

R. L. Foote
Design Studio



Large Collector Bubble Bowl:
Purple - Partial Coverage



Large Collector Bubble Bowl:
Orange & blue - Partial Coverage



Large Collector Bubble Bowl:
Light Blue & Bright Green - Partial
Coverage



Large Collector Bubble Bowl:
Blue & Light Blue - Partial Coverage



Large Collector Bubble Bowl:
Red - Full Coverage



Large Collector Bubble Bowl:
Blue & Green - Partial Coverage



Large Collector Bubble Bowl:
Red/Black - Full Coverage

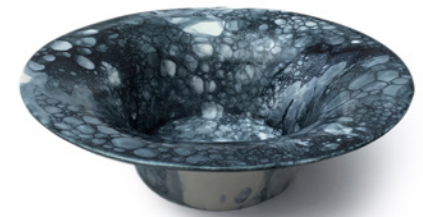

Large Collector Bubble Bowl:
Black/Blue - Full Coverage

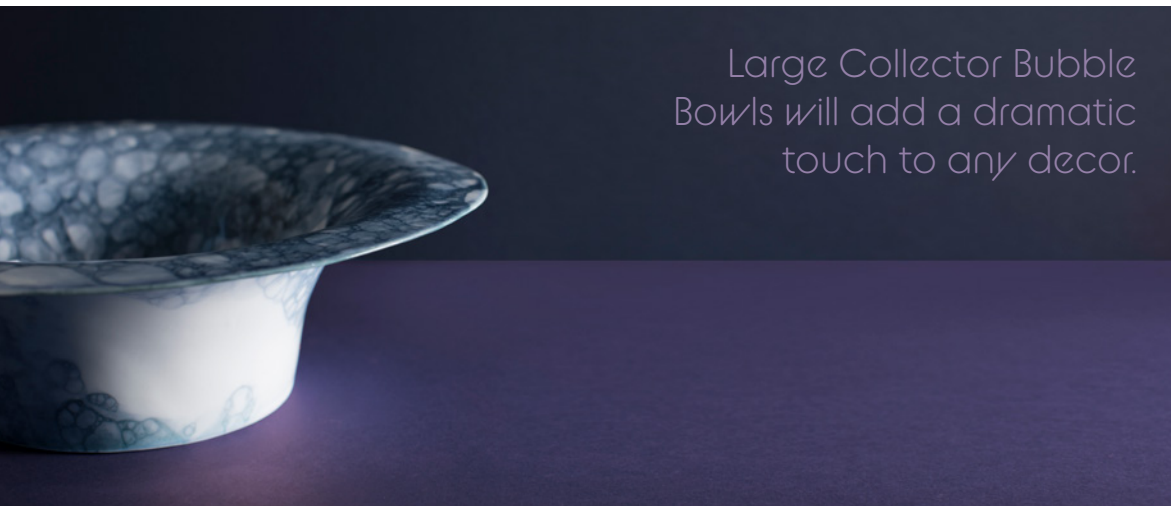

Large Collector Bubble
Bowls will add a dramatic
touch to any decor.

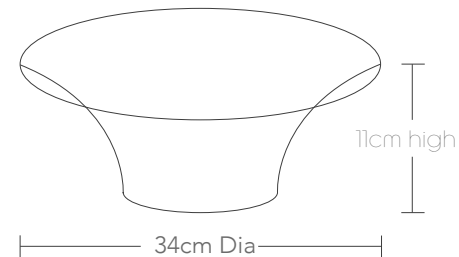

Large Collector Bubble Bowl:
Pink & Blue - Partial Coverage

Splash Range

R. L. Foote
Design Studio

Available in two sizes and a range of colours.
Specific tones and combinations
can be made on request.

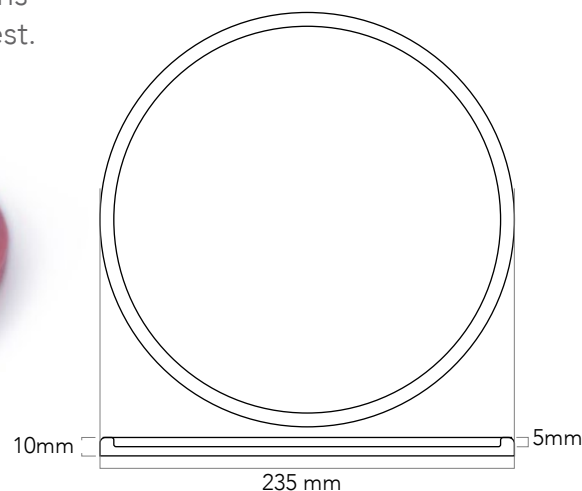

235 mm

SP-02-

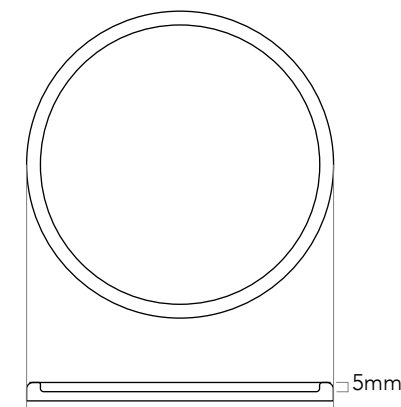

174 mm

SP-01-

Colour code to go after SKU code

YB (Blue with Yellow), BG (Green with Blue)
PB (Light Blue with Pink), BR (Red with Blue), PW (White with Pink)

Featuring a painterly
hand applied
porcelain splash, this
fun range will add a
playful touch to any
recipe from mains to
desserts!



Two tone Range

R. L. Foote
Design Studio

The two tone ones will be white on the inside and one of your secondary tone on the outside.



Two Tone Plate :
pink, orange, red, blue, light blue,
green, black, white

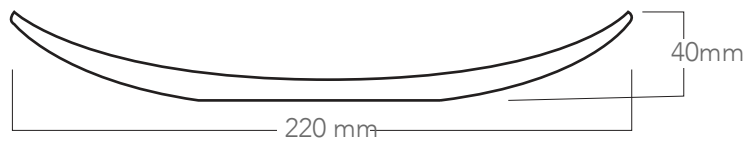

Aroma Range

R. L. Foote
Design Studio



Aroma: Aroma Capsule - Double
7.5cm dia x 155cm



Aroma: Aroma Capsule - Double Tall
7.5cm dia x 170cm



Aroma: Aroma Capsule - Single
7.5cm dia x 7.5cm



Aroma: Aroma Capsule - Single tall
7.5cm dia x 9cm



Aroma Range pushes the boundaries of traditional food and drink pairing to a playful and interactive experience with an exciting aroma element added into the mix.



Aroma Range

R. L. Foote
Design Studio



Aroma: Bell Jar - White
9.3cm dia x 11cm



Aroma: Bell Jar - Black
9.3cm dia x 11cm

Both the *Aroma Capsules* and *Bell Jar* collections capture aromas inside their forms *whether it be steam, smoke, essential oils* giving guests an aromatic burst *when opened.*

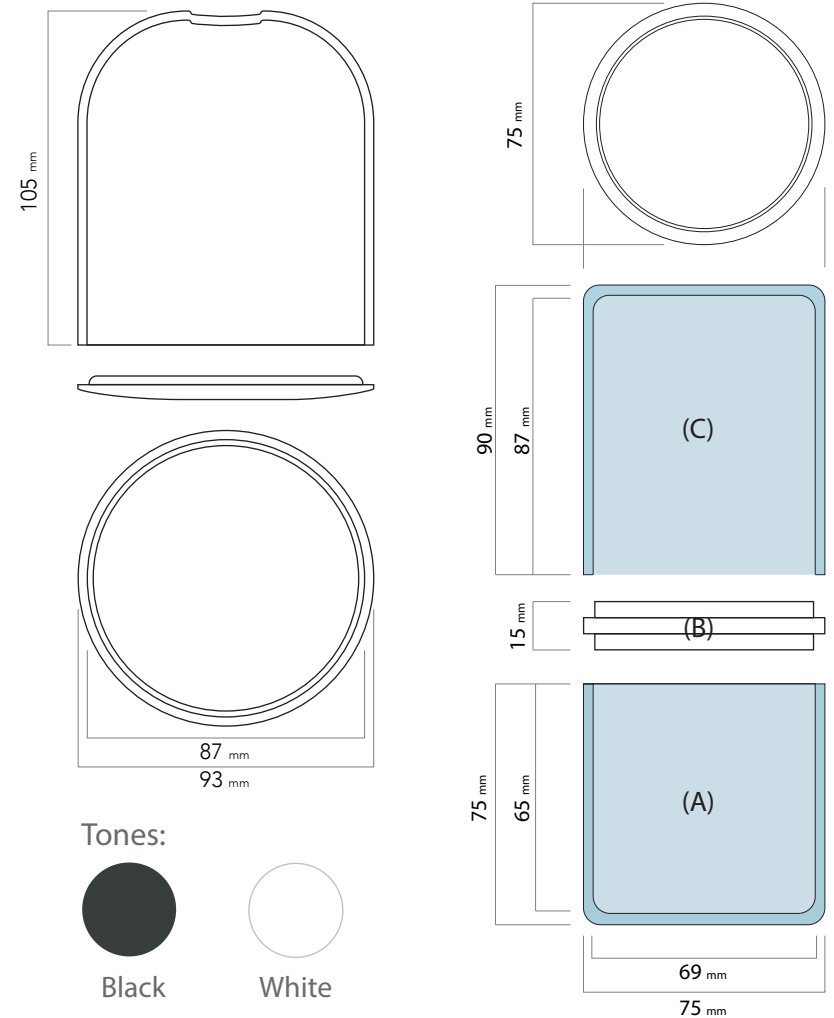

Custom Designs

R L Foote Design Studio can create costume pieces to suit your needs if your a restaurant, bar, hotel, or corporate customer, we can help from customising some of our existing collections, complete new designs and glazes to even manufacturing your designs under your brand.

If your looking for something you cant find anywhere else we would love to help.

Please reach out and tell us what you're looking for.

Terms & Conditions

The wholesale prices are valid for chefs, restaurants, retail or gallery shops, kitchen supply centres, approved resellers, food, interior & prop stylists. By accepting wholesale pricing, you agree to credit R L Foote Design Studio in any publication of images featuring the work - digital or otherwise (including but not limited to social media, websites & printed material such as cookbooks etc).

We check each piece carefully before shipping it out. However, as all our pieces are delicately crafted by hand, there might be slight variances in size, colour, texture or pattern etc that we do not consider defects, but rather the uniqueness of an artisanal product.

Delivery & Shipping

Standard turnaround time is 2-8 weeks before shipment unless the items are in stock. This may be longer (for larger orders, if poor weather increases drying/firing time, or we have large scale projects underway). Please discuss your deadlines with us before ordering.

We will include the shipping price in your quote. We are not responsible for any taxes or duties that may be incurred on international orders.

Breakages

If some of the items had arrived broken, please email us a photo of the broken goods as it had arrived in the packaging within 5 days of receipt. We will arrange to send replacement pieces.

R. L. Foote Design Studio



Visit

1 Parslow Street, Clifton Hill 3068
Victoria, Australia

Onsite parking available
(main entrance via parking lot at end of the street)

Contact:

www.RLFooteDesign.com

info@rlfootedesign.com

IG: [@rlfootedesignstudio](https://www.instagram.com/rlfootedesignstudio)

+61 (0) 404 873 127